

PNP Silicon Switching Transistor

- High DC current gain: 0.1mA to 100mA
- Low collector-emitter saturation voltage
- Complementary type: SMBT 3904 (NPN)

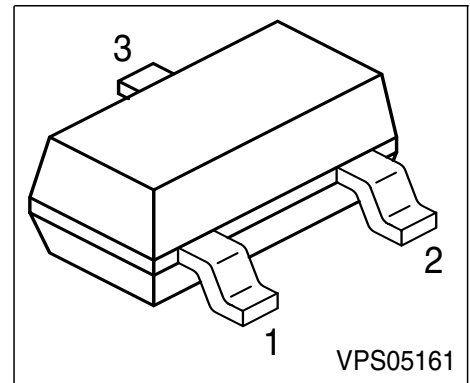

Type	Marking	Pin Configuration			Package
SMBT 3906	s2A	1 = B	2 = E	3 = C	SOT-23

Maximum Ratings

Parameter	Symbol	Value	Unit
Collector-emitter voltage	V_{CEO}	40	V
Collector-base voltage	V_{CBO}	40	
Emitter-base voltage	V_{EBO}	5	
DC collector current	I_C	200	mA
Total power dissipation, $T_S = 71\text{ °C}$	P_{tot}	330	mW
Junction temperature	T_j	150	°C
Storage temperature	T_{stg}	-65 ... 150	

Thermal Resistance

Junction ambient ¹⁾	R_{thJA}	≤310	K/W
Junction - soldering point	R_{thJS}	≤240	

1) Package mounted on pcb 40mm x 40mm x 1.5mm / 6cm² Cu

Electrical Characteristics at $T_A = 25^\circ\text{C}$, unless otherwise specified.

Parameter	Symbol	Values			Unit
		min.	typ.	max.	
DC Characteristics					
Collector-emitter breakdown voltage $I_C = 1\text{ mA}, I_B = 0$	$V_{(BR)CEO}$	40	-	-	V
Collector-base breakdown voltage $I_C = 10\text{ }\mu\text{A}, I_B = 0$	$V_{(BR)CBO}$	40	-	-	
Emitter-base breakdown voltage $I_E = 10\text{ }\mu\text{A}, I_C = 0$	$V_{(BR)EBO}$	5	-	-	
Collector cutoff current $V_{CB} = 30\text{ V}, I_E = 0$	I_{CBO}	-	-	50	nA
DC current gain 1) $I_C = 100\text{ }\mu\text{A}, V_{CE} = 1\text{ V}$ $I_C = 1\text{ mA}, V_{CE} = 1\text{ V}$ $I_C = 10\text{ mA}, V_{CE} = 1\text{ V}$ $I_C = 50\text{ mA}, V_{CE} = 1\text{ V}$ $I_C = 100\text{ mA}, V_{CE} = 1\text{ V}$	h_{FE}	60 80 100 60 30	- - - - -	- - 300 - -	-
Collector-emitter saturation voltage1) $I_C = 10\text{ mA}, I_B = 1\text{ mA}$ $I_C = 50\text{ mA}, I_B = 5\text{ mA}$	V_{CEsat}	- -	- -	0.25 0.4	V
Base-emitter saturation voltage 1) $I_C = 10\text{ mA}, I_B = 1\text{ mA}$ $I_C = 10\text{ mA}, I_B = 1\text{ mA}$	V_{BEsat}	0.65 -	- -	0.85 0.95	

 1) Pulse test: $t \leq 300\mu\text{s}$, $D = 2\%$

Electrical Characteristics at $T_A = 25^\circ\text{C}$, unless otherwise specified.

Parameter	Symbol	Values			Unit
		min.	typ.	max.	
AC Characteristics					
Transition frequency $I_C = 10\text{ mA}, V_{CE} = 20\text{ V}, f = 100\text{ MHz}$	f_T	250	-	-	MHz
Collector-base capacitance $V_{CB} = 5\text{ V}, f = 1\text{ MHz}$	C_{cb}	-	-	4.5	pF
Emitter-base capacitance $V_{EB} = 0.5\text{ V}, f = 1\text{ MHz}$	C_{eb}	-	-	10	
Noise figure $I_C = 100\text{ }\mu\text{A}, V_{CE} = 5\text{ V}, R_S = 1\text{ k}\Omega,$ $f = 1\text{ kHz}, \Delta f = 200\text{ Hz}$	F	-	-	4	dB
Short-circuit input impedance $I_C = 1\text{ mA}, V_{CE} = 10\text{ V}, f = 1\text{ kHz}$	h_{11e}	2	-	12	k Ω
Open-circuit reverse voltage transf.ratio $I_C = 1\text{ mA}, V_{CE} = 10\text{ V}, f = 1\text{ kHz}$	h_{12e}	0.1	-	10	10^{-4}
Short-circuit forward current transf.ratio $I_C = 1\text{ mA}, V_{CE} = 10\text{ V}, f = 1\text{ kHz}$	h_{21e}	100	-	400	-
Open-circuit output admittance $I_C = 1\text{ mA}, V_{CE} = 10\text{ V}, f = 1\text{ kHz}$	h_{22e}	3	-	60	μS
Delay time $V_{CC} = 3\text{ V}, I_C = 10\text{ mA}, I_{B1} = 1\text{ mA},$ $V_{BE(\text{off})} = 0.5\text{ V}$	t_d	-	-	35	ns
Rise time $V_{CC} = 3\text{ V}, I_C = 10\text{ mA}, I_{B1} = 1\text{ mA},$ $V_{BE(\text{off})} = 0.5\text{ V}$	t_r	-	-	35	
Storage time $V_{CC} = 3\text{ V}, I_C = 10\text{ mA}, I_{B1}=I_{B2} = 1\text{ mA}$	t_{stg}	-	-	225	
Fall time $V_{CC} = 3\text{ V}, I_C = 10\text{ mA}, I_{B1}=I_{B2} = 1\text{ mA}$	t_f	-	-	75	

Test circuits

Delay and rise time

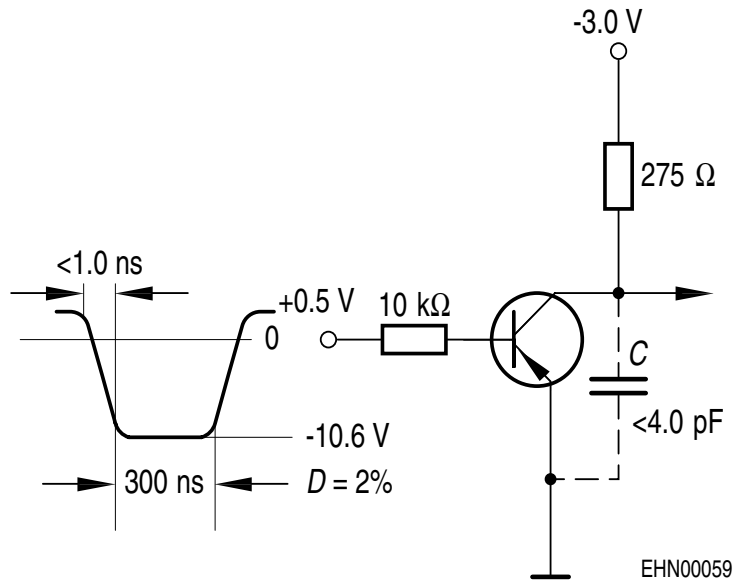

Storage and fall time

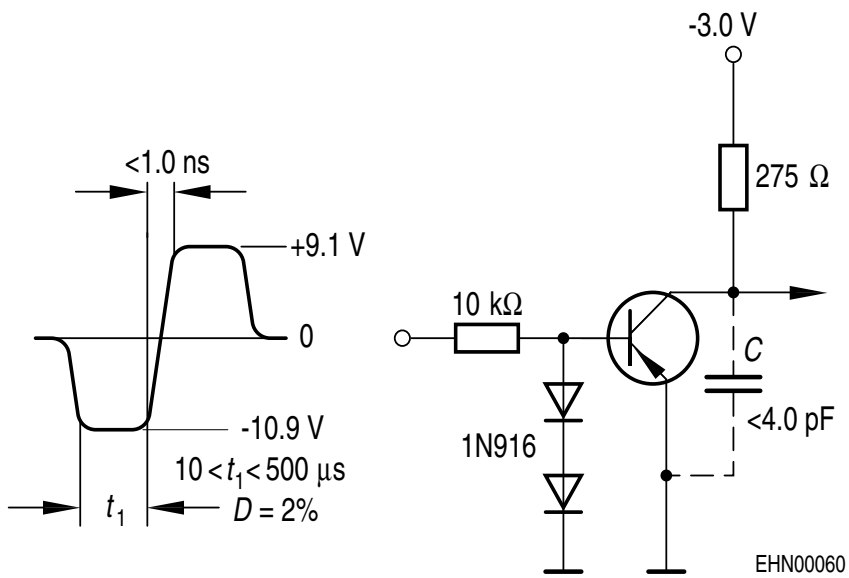

Total power dissipation $P_{tot} = f(T_A^*; T_S)$

* Package mounted on epoxy

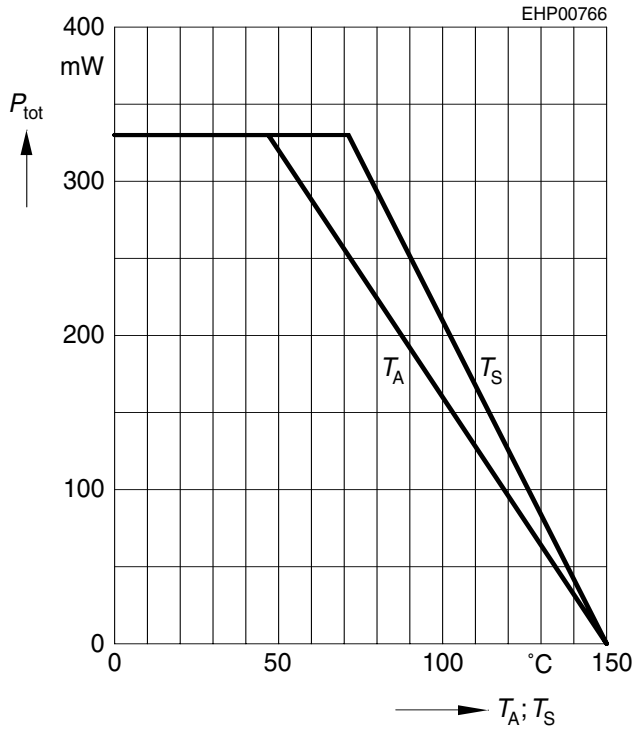

Saturation voltage $I_C = f(V_{BEsat}, V_{CEsat})$

$h_{FE} = 10$

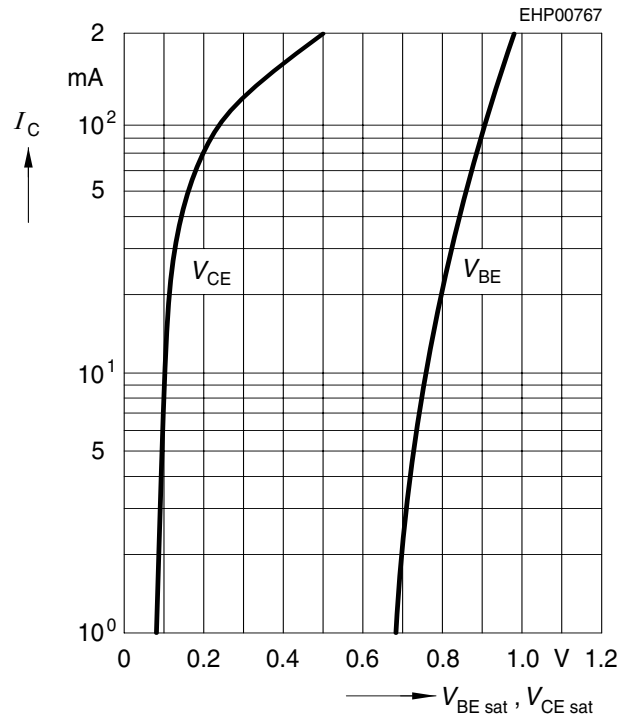

Permissible pulse load

$P_{totmax} / P_{totDC} = f(t_p)$

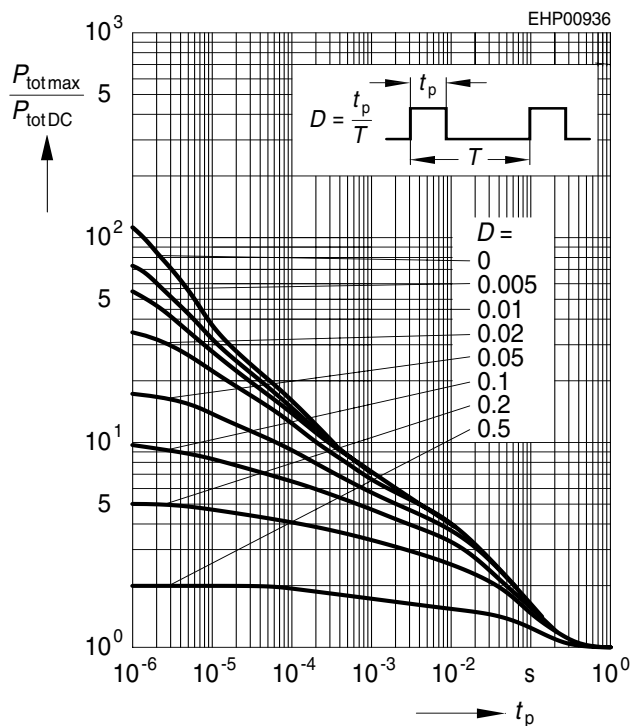

DC current gain $h_{FE} = f(I_C)$

$V_{CE} = 1V$, normalized

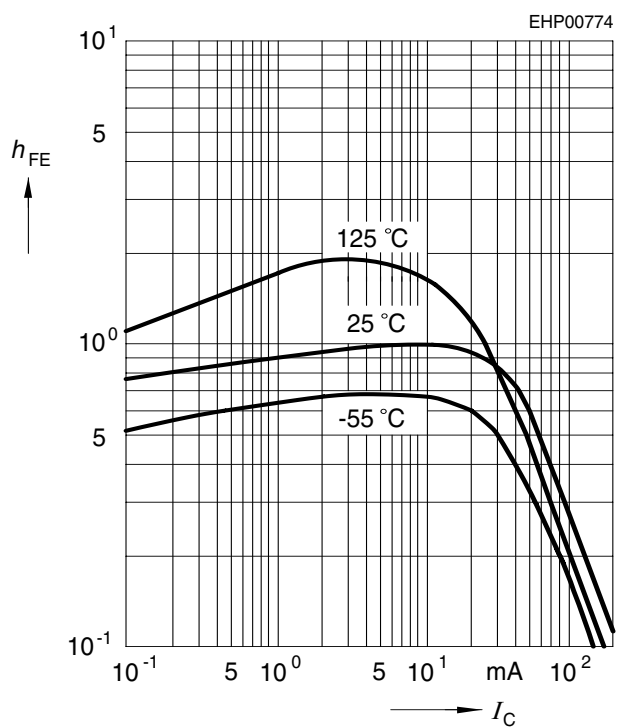

Short-circuit forward current

transfer ratio $h_{21e} = f(I_C)$

$V_{CE} = 10V, f = 1MHz$

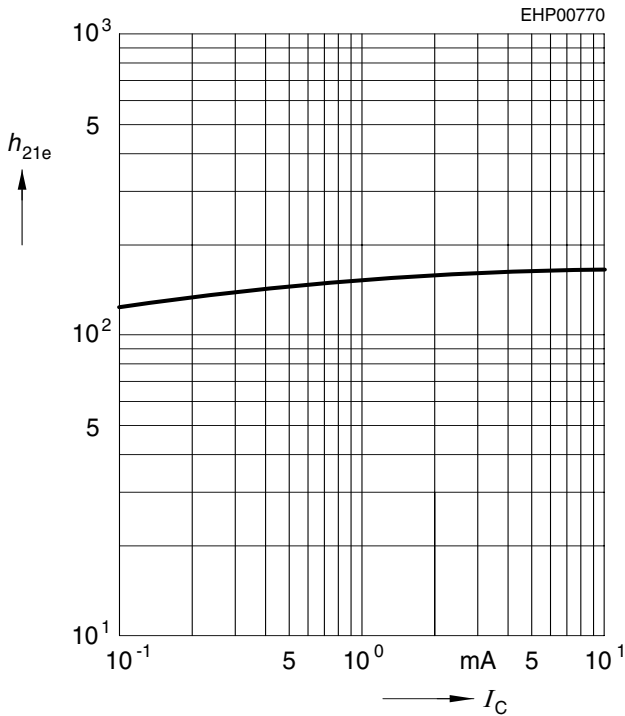

Open-circuit output admittance

$h_{22e} = f(I_C)$

$V_{CE} = 10V, f = 1MHz$

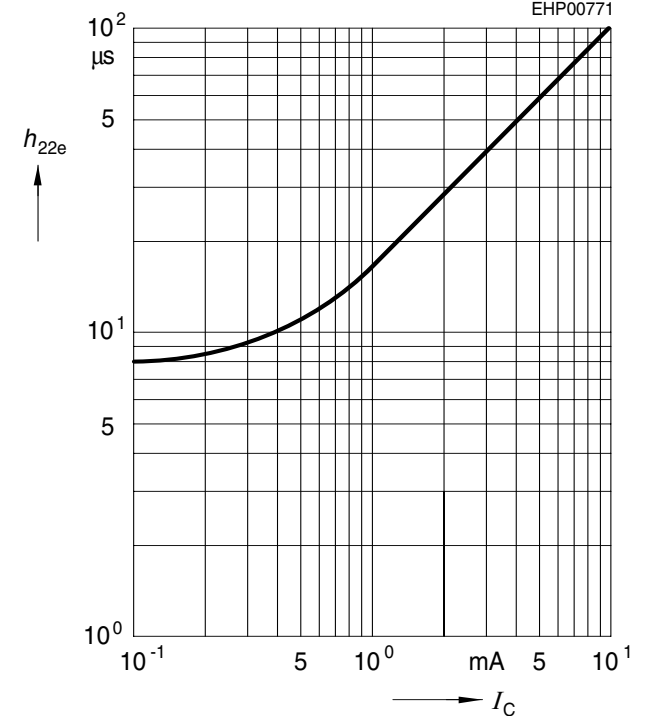

Delay time $t_d = f(I_C)$

Rise time $t_r = f(I_C)$

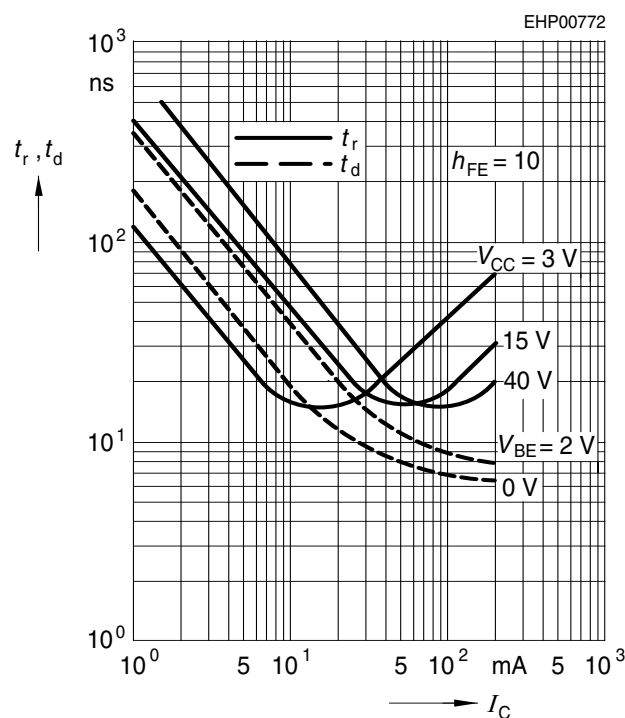

Fall time $t_f = f(I_C)$

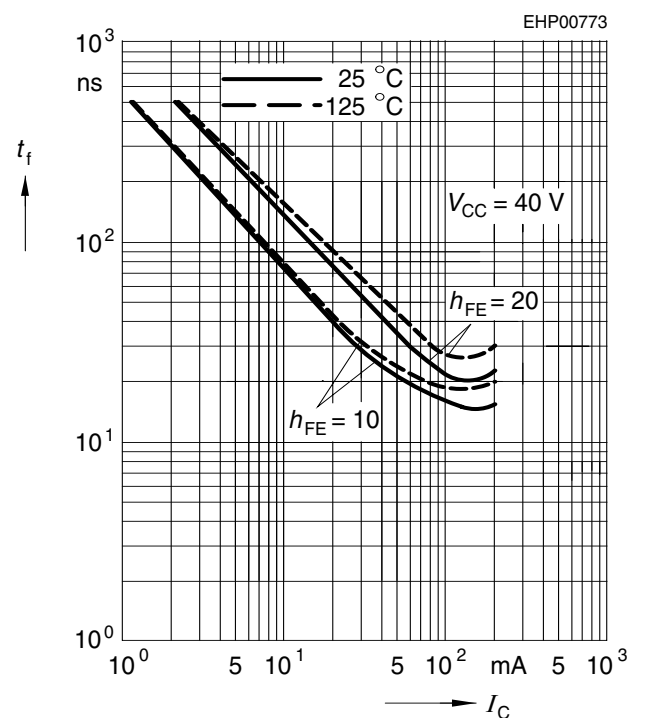

Short-circuit input impedance

$$h_{11e} = f(I_C)$$

$V_{CE} = 10V, f = 1kHz$

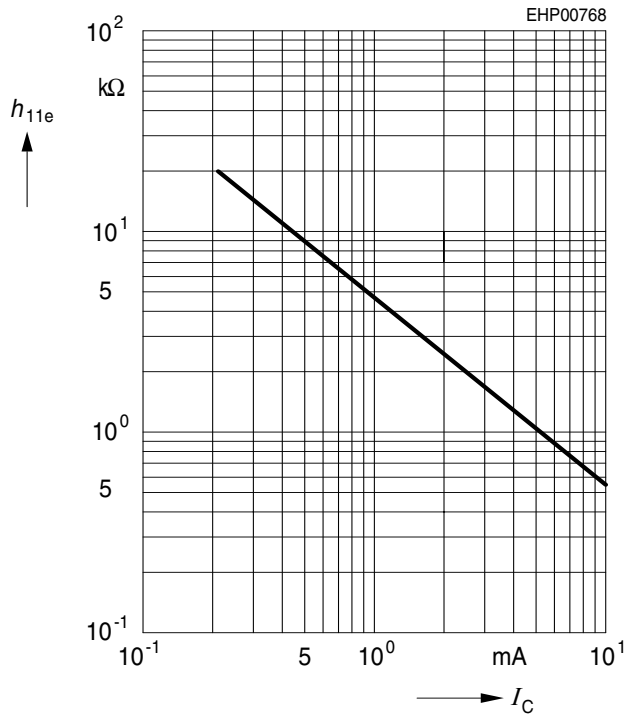

Open-circuit reverse voltage transfer ratio

$$h_{12e} = f(I_C)$$

$V_{CE} = 10V, f = 1kHz$

